

PDTC115T series

NPN resistor-equipped transistors; R1 = 100 k Ω , R2 = open

Rev. 04 — 17 February 2005

Product data sheet

1. Product profile

1.1 General description

NPN resistor-equipped transistors.

Table 1: Product overview

Type number	Package		PNP complement
	Philips	JEITA	
PDTC115TE	SOT416	SC-75	PDTA115TE
PDTC115TK	SOT346	SC-59A	PDTA115TK
PDTC115TM	SOT883	SC-101	PDTA115TM
PDTC115TS [1]	SOT54 (TO-92)	SC-43A	PDTA115TS
PDTC115TT	SOT23	-	PDTA115TT
PDTC115TU	SOT323	SC-70	PDTA115TU

[1] Also available in SOT54A and SOT54 variant packages (see [Section 2](#)).

1.2 Features

- Built-in bias resistor
- Simplifies circuit design
- Reduces component count
- Reduces pick and place costs

1.3 Applications

- General-purpose switching and amplification
- Inverter and interface circuits
- Circuit drivers

1.4 Quick reference data

Table 2: Quick reference data

Symbol	Parameter	Conditions	Min	Typ	Max	Unit
V_{CEO}	collector-emitter voltage	open base	-	-	50	V
I_O	output current (DC)		-	-	100	mA
R1	bias resistor 1 (input)		70	100	130	k Ω

PHILIPS

2. Pinning information

Table 3: Pinning

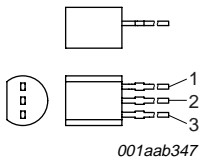
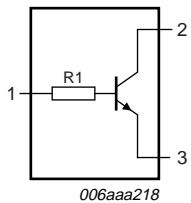
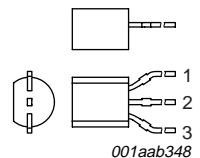
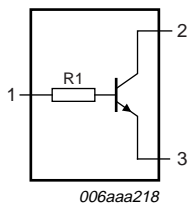
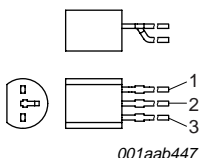
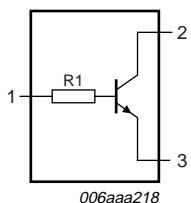
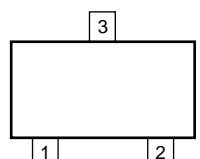
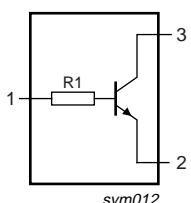
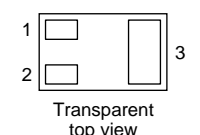
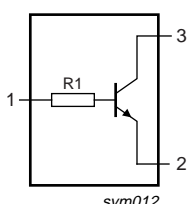
Pin	Description	Simplified outline	Symbol
SOT54			
1	input (base)	 <p>001aab347</p>	 <p>006aaa218</p>
2	output (collector)		
3	GND (emitter)		
SOT54A			
1	input (base)	 <p>001aab348</p>	 <p>006aaa218</p>
2	output (collector)		
3	GND (emitter)		
SOT54 variant			
1	input (base)	 <p>001aab447</p>	 <p>006aaa218</p>
2	output (collector)		
3	GND (emitter)		
SOT23, SOT323, SOT346, SOT416			
1	input (base)	 <p>006aaa144</p>	 <p>sym012</p>
2	GND (emitter)		
3	output (collector)		
SOT883			
1	input (base)	 <p>Transparent top view</p>	 <p>sym012</p>
2	GND (emitter)		
3	output (collector)		

3. Ordering information

Table 4: Ordering information

Type number	Package		
	Name	Description	Version
PDTC115TE	SC-75	plastic surface mounted package; 3 leads	SOT416
PDTC115TK	SC-59A	plastic surface mounted package; 3 leads	SOT346
PDTC115TM	SC-101	leadless ultra small plastic package; 3 solder lands; body 1.0 × 0.6 × 0.5 mm	SOT883
PDTC115TS ^[1]	SC-43A	plastic single-ended leaded (through hole) package; 3 leads	SOT54
PDTC115TT	-	plastic surface mounted package; 3 leads	SOT23
PDTC115TU	SC-70	plastic surface mounted package; 3 leads	SOT323

[1] Also available in SOT54A and SOT54 variant packages (see [Section 2](#) and [Section 9](#)).

4. Marking

Table 5: Marking codes

Type number	Marking code ^[1]
PDTC115TE	17
PDTC115TK	28
PDTC115TM	G5
PDTC115TS	TC115T
PDTC115TT	*AK
PDTC115TU	*17

[1] * = -: made in Hong Kong
 * = p: made in Hong Kong
 * = t: made in Malaysia
 * = W: made in China

5. Limiting values

Table 6: Limiting values

In accordance with the Absolute Maximum Rating System (IEC 60134).

Symbol	Parameter	Conditions	Min	Max	Unit
V _{CBO}	collector-base voltage	open emitter	-	50	V
V _{CEO}	collector-emitter voltage	open base	-	50	V
V _{EBO}	emitter-base voltage	open collector	-	5	V
I _O	output current (DC)		-	100	mA
I _{CM}	peak collector current		-	100	mA
P _{tot}	total power dissipation				
	SOT416	T _{amb} ≤ 25 °C	[1] -	150	mW
	SOT346	T _{amb} ≤ 25 °C	[1] -	250	mW
	SOT883	T _{amb} ≤ 25 °C	[2] [3] -	250	mW
	SOT54	T _{amb} ≤ 25 °C	[1] -	500	mW
	SOT23	T _{amb} ≤ 25 °C	[1] -	250	mW
	SOT323	T _{amb} ≤ 25 °C	[1] -	200	mW
T _{stg}	storage temperature		-65	+150	°C
T _j	junction temperature		-	150	°C
T _{amb}	ambient temperature		-65	+150	°C

[1] Refer to standard mounting conditions.

[2] Reflow soldering is the only recommended soldering method.

[3] Refer to SOT883 standard mounting conditions; FR4 printed-circuit board with 60 μ m copper strip line.

6. Thermal characteristics

Table 7: Thermal characteristics

Symbol	Parameter	Conditions	Min	Typ	Max	Unit
R _{th(j-a)}	thermal resistance from junction to ambient	in free air				
	SOT416		[1] -	-	833	K/W
	SOT346		[1] -	-	500	K/W
	SOT883		[2] [3] -	-	500	K/W
	SOT54		[1] -	-	250	K/W
	SOT23		[1] -	-	500	K/W
	SOT323		[1] -	-	625	K/W

[1] Refer to standard mounting conditions.

[2] Reflow soldering is the only recommended soldering method.

[3] Refer to SOT883 standard mounting conditions; FR4 printed-circuit board with 60 μ m copper strip line.

7. Characteristics

Table 8: Characteristics

$T_{amb} = 25\text{ °C}$ unless otherwise specified.

Symbol	Parameter	Conditions	Min	Typ	Max	Unit
I_{CBO}	collector-base cut-off current	$V_{CB} = 50\text{ V}; I_E = 0\text{ A}$	-	-	100	nA
I_{CEO}	collector-emitter cut-off current	$V_{CE} = 30\text{ V}; I_B = 0\text{ A}$	-	-	1	μA
		$V_{CE} = 30\text{ V}; I_B = 0\text{ A}; T_j = 150\text{ °C}$	-	-	50	μA
I_{EBO}	emitter-base cut-off current	$V_{EB} = 5\text{ V}; I_C = 0\text{ A}$	-	-	100	nA
h_{FE}	DC current gain	$V_{CE} = 5\text{ V}; I_C = 1\text{ mA}$	100	-	-	
V_{CEsat}	collector-emitter saturation voltage	$I_C = 5\text{ mA}; I_B = 0.25\text{ mA}$	-	-	150	mV
R1	bias resistor 1 (input)		70	100	130	kΩ
C_c	collector capacitance	$I_E = i_e = 0\text{ A}; V_{CB} = 10\text{ V}; f = 1\text{ MHz}$	-	-	2.5	pF

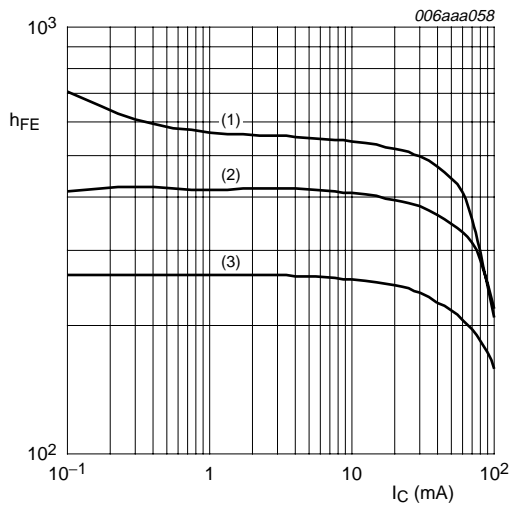

$V_{CE} = 5\text{ V}$

- (1) $T_{amb} = 100\text{ °C}$
- (2) $T_{amb} = 25\text{ °C}$
- (3) $T_{amb} = -40\text{ °C}$

Fig 1. DC current gain as a function of collector current; typical values

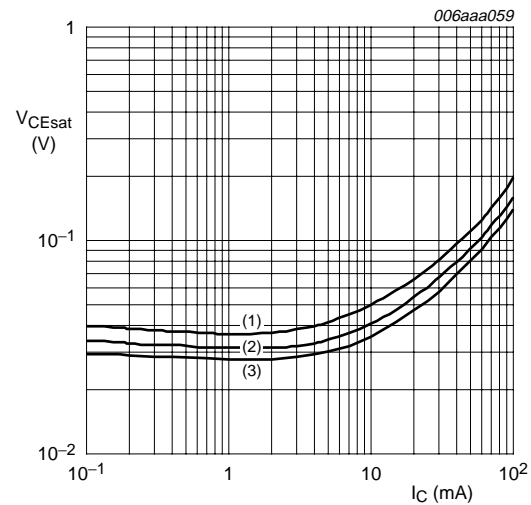

$I_C/I_B = 20$

- (1) $T_{amb} = 100\text{ °C}$
- (2) $T_{amb} = 25\text{ °C}$
- (3) $T_{amb} = -40\text{ °C}$

Fig 2. Collector-emitter saturation voltage as a function of collector current; typical values

8. Package outline

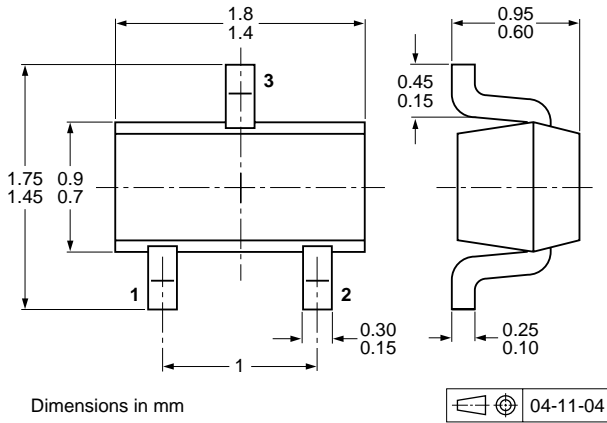

Fig 3. Package outline SOT416 (SC-75)

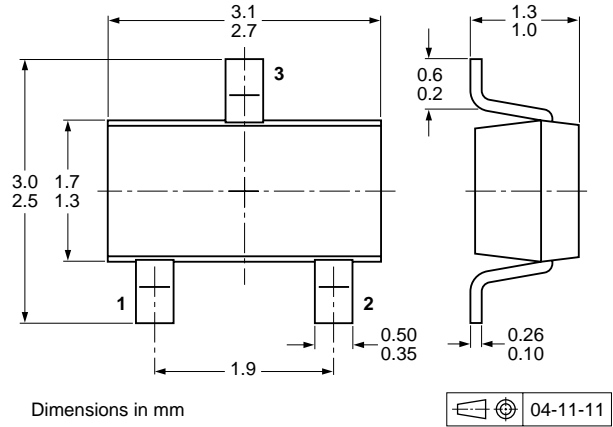

Fig 4. Package outline SOT346 (SC-59A/TO-236)

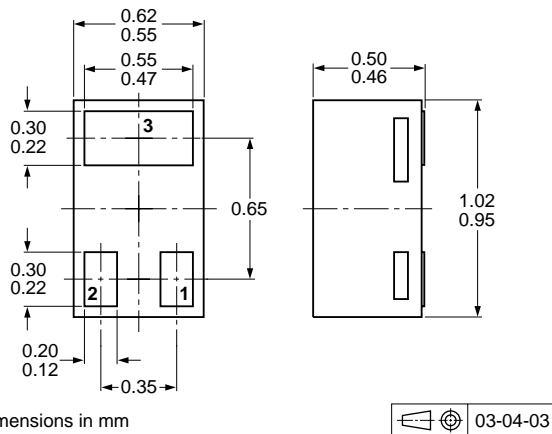

Fig 5. Package outline SOT883 (SC-101)

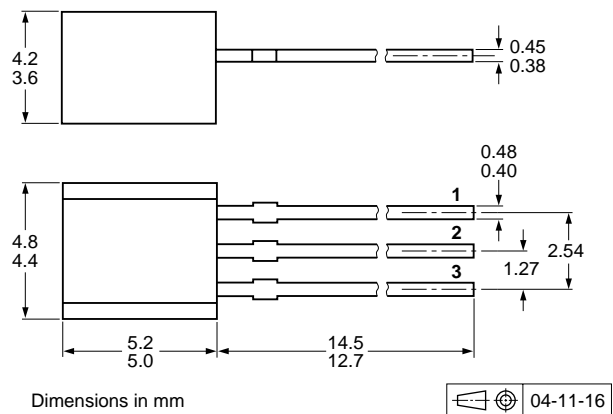

Fig 6. Package outline SOT54 (SC-43A/TO-92)

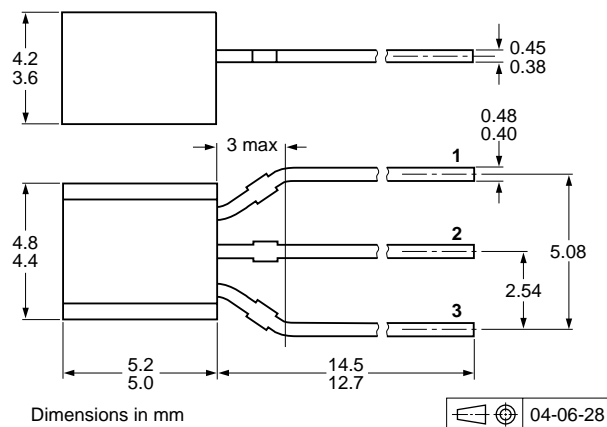

Fig 7. Package outline SOT54A

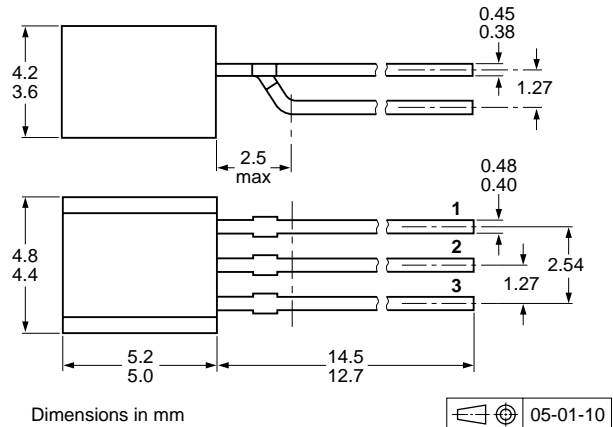
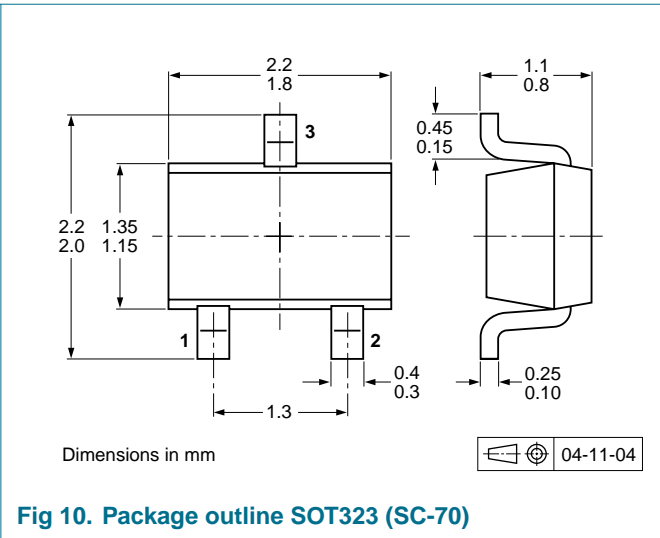
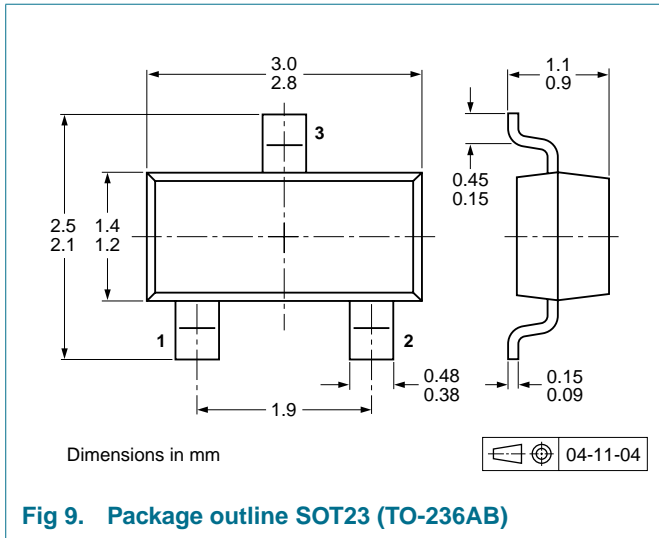

Fig 8. Package outline SOT54 variant



9. Packing information

Table 9: Packing methods

The indicated -xxx are the last three digits of the 12NC ordering code. [1]

Type number	Package	Description	Packing quantity		
			3000	5000	10000
PDTC115TE	SOT416	4 mm pitch, 8 mm tape and reel	-115	-	-135
PDTC115TK	SOT346	4 mm pitch, 8 mm tape and reel	-115	-	-135
PDTC115TM	SOT883	2 mm pitch, 8 mm tape and reel	-	-	-315
PDTC115TS	SOT54	bulk, straight leads	-	-412	-
PDTC115TS	SOT54A	tape and reel, wide pitch	-	-	-116
PDTC115TS	SOT54A	tape ammopack, wide pitch	-	-	-126
PDTC115TS	SOT54 variant	bulk, delta pinning	-	-112	-
PDTC115TT	SOT23	4 mm pitch, 8 mm tape and reel	-215	-	-235
PDTC115TU	SOT323	4 mm pitch, 8 mm tape and reel	-115	-	-135

[1] For further information and the availability of packing methods, see [Section 14](#).

10. Revision history

Table 10: Revision history

Document ID	Release date	Data sheet status	Change notice	Doc. number	Supersedes
PDTC115T_SER_4	20050217	Product data sheet	-	9397 750 14021	PDTC115TT_3
Modifications	<ul style="list-style-type: none"> The types PDTC115TE, PDTC115TK, PDTC115TM, PDTC115TS and PDTC115TU were added. Table 1 "Product overview" added Figure 1 and 2 added Section 9 "Packing information" added 				
PDTC115TT_3	20040727	Product data sheet	-	9397 750 13505	PDTC115TT_2
PDTC115TT_2	20040510	Objective data sheet	-	9397 750 13206	PDTC115TT_1
PDTC115TT_1	20040305	Objective data sheet	-	9397 750 12554	-

11. Data sheet status

Level	Data sheet status ^[1]	Product status ^[2] ^[3]	Definition
I	Objective data	Development	This data sheet contains data from the objective specification for product development. Philips Semiconductors reserves the right to change the specification in any manner without notice.
II	Preliminary data	Qualification	This data sheet contains data from the preliminary specification. Supplementary data will be published at a later date. Philips Semiconductors reserves the right to change the specification without notice, in order to improve the design and supply the best possible product.
III	Product data	Production	This data sheet contains data from the product specification. Philips Semiconductors reserves the right to make changes at any time in order to improve the design, manufacturing and supply. Relevant changes will be communicated via a Customer Product/Process Change Notification (CPCN).

[1] Please consult the most recently issued data sheet before initiating or completing a design.

[2] The product status of the device(s) described in this data sheet may have changed since this data sheet was published. The latest information is available on the Internet at URL <http://www.semiconductors.philips.com>.

[3] For data sheets describing multiple type numbers, the highest-level product status determines the data sheet status.

12. Definitions

Short-form specification — The data in a short-form specification is extracted from a full data sheet with the same type number and title. For detailed information see the relevant data sheet or data handbook.

Limiting values definition — Limiting values given are in accordance with the Absolute Maximum Rating System (IEC 60134). Stress above one or more of the limiting values may cause permanent damage to the device. These are stress ratings only and operation of the device at these or at any other conditions above those given in the Characteristics sections of the specification is not implied. Exposure to limiting values for extended periods may affect device reliability.

Application information — Applications that are described herein for any of these products are for illustrative purposes only. Philips Semiconductors make no representation or warranty that such applications will be suitable for the specified use without further testing or modification.

13. Disclaimers

Life support — These products are not designed for use in life support appliances, devices, or systems where malfunction of these products can reasonably be expected to result in personal injury. Philips Semiconductors customers using or selling these products for use in such applications do so at their own risk and agree to fully indemnify Philips Semiconductors for any damages resulting from such application.

Right to make changes — Philips Semiconductors reserves the right to make changes in the products - including circuits, standard cells, and/or software - described or contained herein in order to improve design and/or performance. When the product is in full production (status 'Production'), relevant changes will be communicated via a Customer Product/Process Change Notification (CPCN). Philips Semiconductors assumes no responsibility or liability for the use of any of these products, conveys no license or title under any patent, copyright, or mask work right to these products, and makes no representations or warranties that these products are free from patent, copyright, or mask work right infringement, unless otherwise specified.

14. Contact information

For additional information, please visit: <http://www.semiconductors.philips.com>

For sales office addresses, send an email to: sales.addresses@www.semiconductors.philips.com

15. Contents

1	Product profile	1
1.1	General description	1
1.2	Features	1
1.3	Applications	1
1.4	Quick reference data	1
2	Pinning information	2
3	Ordering information	3
4	Marking	3
5	Limiting values	4
6	Thermal characteristics	4
7	Characteristics	5
8	Package outline	6
9	Packing information	7
10	Revision history	8
11	Data sheet status	9
12	Definitions	9
13	Disclaimers	9
14	Contact information	9



© Koninklijke Philips Electronics N.V. 2005

All rights are reserved. Reproduction in whole or in part is prohibited without the prior written consent of the copyright owner. The information presented in this document does not form part of any quotation or contract, is believed to be accurate and reliable and may be changed without notice. No liability will be accepted by the publisher for any consequence of its use. Publication thereof does not convey nor imply any license under patent- or other industrial or intellectual property rights.

Date of release: 17 February 2005
Document number: 9397 750 14021

Published in The Netherlands